

# COCLEE TUBOLARI

## -Bocche Sferiche-

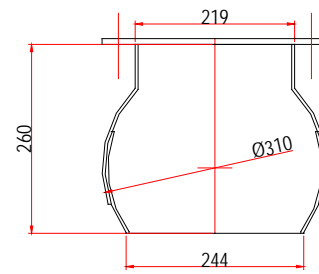
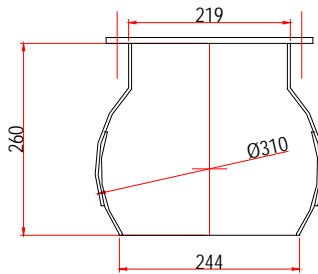
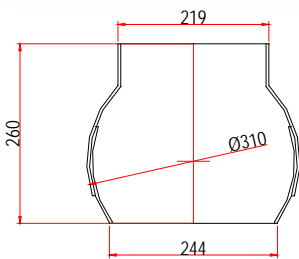
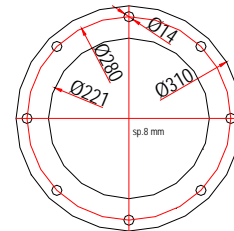
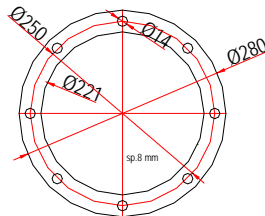

Codice. 28.050.1219  
Bocca sferica regolabile coclea  
Ø 219 per calza gomma para

Codice 28.050.1719  
Bocca sferica flangiata per coclea  
Ø 219 c/flangia Cod. 27.001.1282

Codice 28.050.1720  
Bocca sferica flangiata per coclea  
Ø 219 c/flangia Cod. 27.001.1310

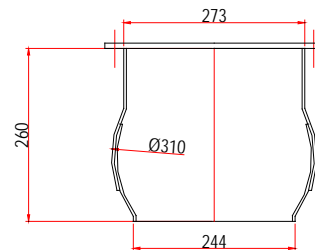
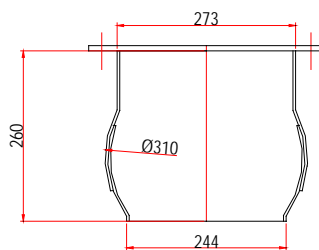
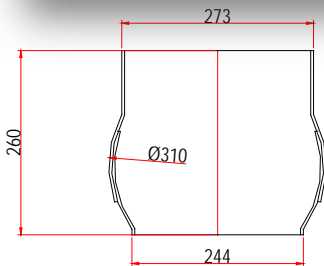
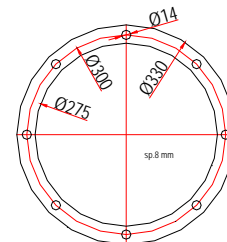
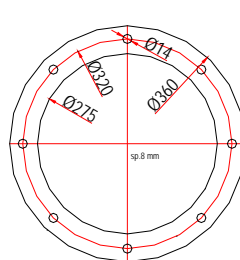

Codice 28.050.1273  
Bocca sferica regolabile coclea  
Ø 273 per calza gomma para

Codice 28.050.1773  
Bocca sferica flangiata per coclea  
Ø 273 c/flangia Cod. 27.001.1330

Codice 28.050.1774  
Bocca sferica flangiata per coclea  
Ø 273 c/flangia Cod. 27.001.1360

COCLEE TUBOLARI



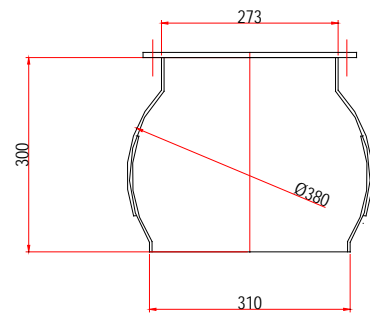
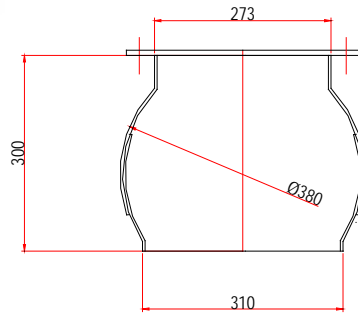
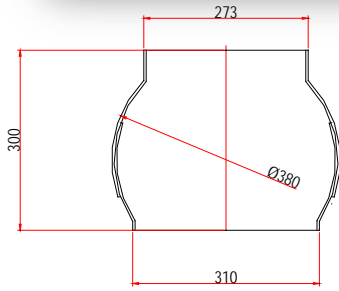
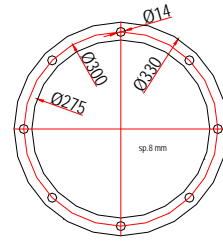
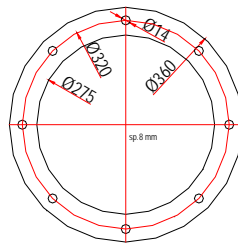

Codice 28.050.1274  
Bocca sferica regolabile coclea  
Ø 273 per calza gomma para

Codice 28.050.1775  
Bocca sferica flangiata per coclea  
Ø 273 c/flangia Cod. 27.001.1360

Codice 28.050.1776  
Bocca sferica flangiata per coclea  
Ø 273 c/flangia Cod. 27.001.1330

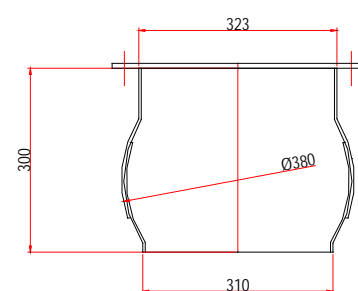
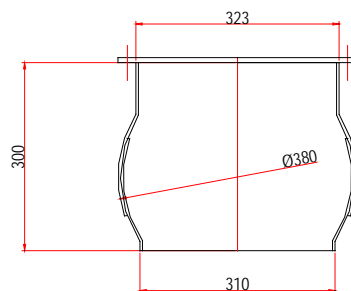
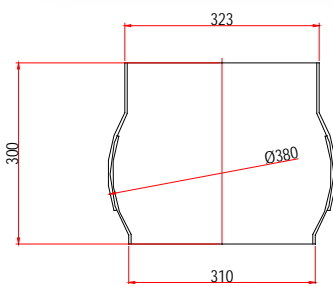
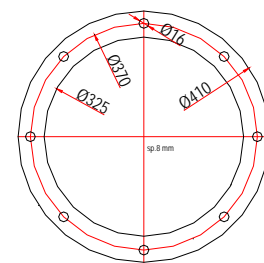
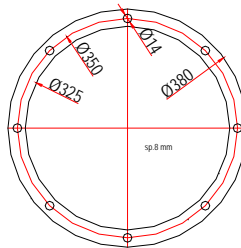

Codice 28.050.1323  
Bocca sferica regolabile coclea  
Ø 323 per calza gomma para

Codice 28.050.1823  
Bocca sferica flangiata per coclea  
Ø 323 c/flangia Cod. 27.001.1380

Codice 28.050.1824  
Bocca sferica flangiata per coclea  
Ø 323 c/flangia Cod. 27.001.1410